

# RCM

## On/Off Remote Control

### INSTALLATION AND OPERATING INSTRUCTIONS

This on/off remote control system provides a safe, reliable, and user-friendly remote control for millivolt valve gas appliances. The system can be manually turned on and off with the transmitter. Always check the appliance home owner's manual for additional information, or warnings regarding accessory installation before connecting this remote control system.

Carefully inspect the contents for shipping damage. If any parts are missing or damaged, immediately contact the dealer from whom you purchased the kit. Do not attempt to install any part of the kit unless all parts are in good condition. Please keep this booklet for future reference.

#### CONTENTS OF KIT

Description	Qty
Transmitter	1
Battery Alkaline AAA ( for Transmitter)	3
Receiver (Assembly) consists of :	1
Receiver Box	
Slide Button-Black (On/RS/Off)	
L-Bracket (Floor Mount)	
Battery Alkaline AA (for Receiver)	4
Wall Cover Plate-Black	1
Wall Cover Plate-White	1
Slide Button-White (On/RS/Off)	1
Screws (for Wall Cover Plate)	2
Plug-In Wiring Assembly – 18” Inches	1
Velcro (Loop and Hook)	1
Installation Instructions	1
Screws (for fireplace system control covers)	2

#### FEATURES/SPECIFICATIONS

- Contemporary Ergonomic Style Transmitter with Large LCD Display
- Backlit LCD Display
- Battery Powered Transmitter and Receiver
- Easy Access Front Battery Door
- Pre-Programmed for Quick Installation
- Low battery Indication
- Child Proof Lock-out
- 256 Security Codes
- Quick Disconnect Wiring Assembly
- Reset Button

**WARNING**  
**Important Safety Information**

- Read this manual thoroughly prior to installing, programming or operating any remote control.
- This remote control system is designed for use with a millivolt gas valve system. Do not use this remote control system on applications with voltages above 30 Volts AC.
- This remote control system requires three (3) “AAA” and four (4) “AA” alkaline batteries to power the transmitter and receiver. Wiring must conform to appliance requirement and building codes/ordinances as required by local and national code authorities having jurisdiction.
- Do not short (or jumper) across the gas valve terminals to test the remote control installation. This could damage the unit and void the warranty.
- This remote control system should only be used as described in this manual. Any other use is not recommended and will void the warranty.

**NOTE**

**Due to the sensitive temperature monitoring components in the transmitter, it is necessary to allow the transmitter to stabilize to room temperature before accurate room temperatures are displayed. If the transmitter is activated from a severe cold condition, allow 15 minutes for accurate temperature readings to appear on the LCD.**

**WARNING**

**Turn appliance OFF and allow to cool before installing or servicing. DO NOT connect 110-120 VAC wiring to the milli-volt gas control valve. The remote operator must be installed exactly as outlined in these instructions. Read all instructions completely before attempting installation. Follow instructions carefully during installation. Any modification of components will void the warranty and may cause a fire hazard.**

## INSTALLATIONS

### ***Remote Receiver:***

The remote receiver may be wall mounted or installed in the appliance per the appliance homeowner's manual. **Refer to the Homeowner's Manual for special installation instructions.** If wall mounted, the remote receiver must be installed in a junction box with cover plate provided. Failure to follow the installation instructions found in the appropriate Homeowner's Manual will void the warranty and may cause a fire hazard.

### Installing Batteries:

The remote receiver uses four (4) "AA"- size batteries. To install batteries,

1. Remove the slide switch by gently pulling straight out.
2. Use your thumb and index finger to gently pull down the L-bracket.
3. Open the battery door by pressing the two tabs located on the door.
4. Install the batteries as indicated in the receiver cover.
5. Close the battery door until the door tab snaps in place.
6. To install the receiver into a wall junction box, install the receiver with the screws provided .
7. If you decided to install the receiver into the appliance, reinstall the L-bracket.
8. Gently, install the slide switch back to the receiver stem.
9. The batteries should be replaced at least once every 6 months or when the battery indicator flashes.

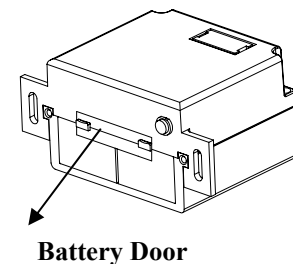
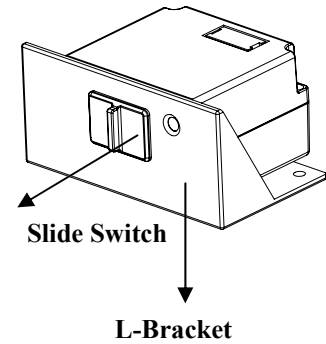

### Installing Wire:

This system comes with an 18 inch pre-assembled wire assembly. Insert the white terminal to the back of the receiver. The terminal wire block can only be installed one way. Do not force the terminal plug onto the receiver.

Follow the homeowner's manual for connecting the two (2) 1/4" female spade terminals to the millivolt valve.

For applications longer than 18 inches, use 18 gauge wire, 105°C rated, with no splices. Connect to the two (2) 1/4" female spade wiring terminals. Wire can be no longer than 20 feet.

**WARNING**

**Make sure that the wires do not contact the appliances any place other than at the terminals. Exposure to temperatures higher than 105C (250°F) may cause the receiver to malfunction or fire hazard.**

**Remote Transmitter:**

Installing Batteries:

The remote transmitter uses three (3) “AAA”- size batteries. To install batteries,

1. Press down the battery door tab and lift up and remove the battery door.
2. Install the batteries as indicated on the receiver cover.
3. Close the battery door by snapping in place.
4. The batteries should be replaced at least once every 6 months or when the battery indicator flashes.

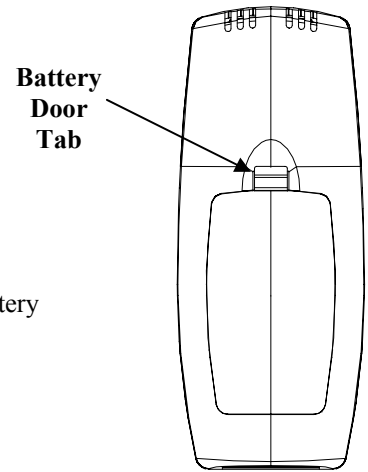

**Back of the Transmitter**

**Setting Privacy (DIP) Switch on Receiver and Transmitter:**

The remote receiver and transmitter privacy (DIP) switches are preset at the factory. Do not set all DIP switches to “OFF” position or “ON” position. The receiver and transmitter privacy (DIP) switches are preset at the factory. In the event of activation or interference from other nearby transmissions, reset the code using the following procedure:

1. Slide the code switches on the transmitter or receiver to your choice of ON or OFF position. Switches #1 to #6 are preset to “ON”, and #7 and #8 are preset to “OFF” for both the transmitter and receiver.
2. The switches on the transmitter and receiver must match in order for the system to work.
3. The system is now ready to operate.

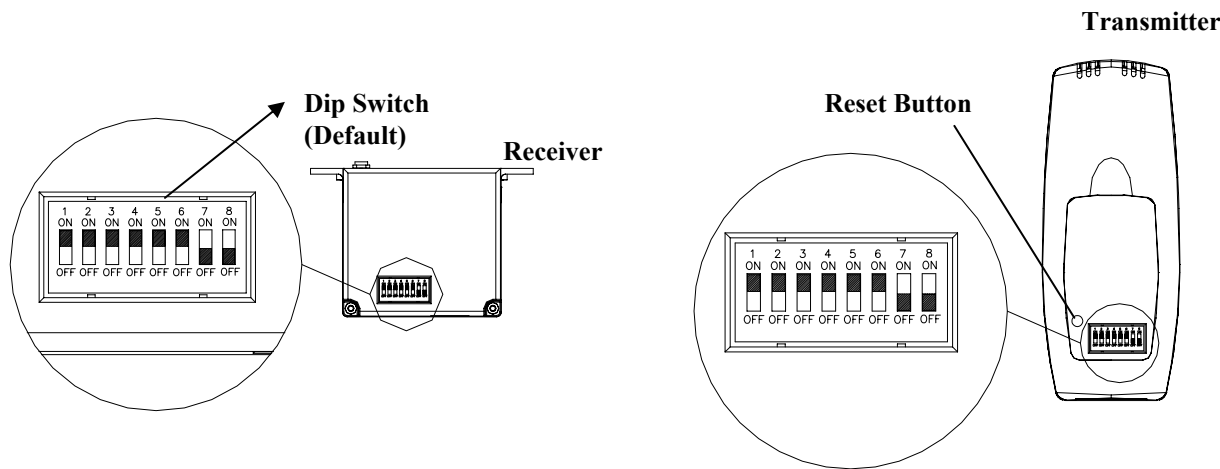

<b>WARNING</b>	<p><b>Do not use two (2) or more remote control systems in the same area with the same dip switch settings, as they will communicate with each other. This may cause the appliances to malfunction.</b></p>
----------------	---

Reset Button:

1. The reset button can be used to reset the systems such as the clock setting. The reset button is located behind the battery door cover.
2. Using a paper clip, press the button and the system will reset and go into clock setting mode. Follow the instructions on how to set the time in the next section.

## OPERATIONS:

### Transmitter:

#### General:

The RCM is an On/Off remote control.

The transmitter will operate the remote receiver from 1 foot to a maximum of 30 feet. The operational range is reduced when batteries are low or when the receiver is inside a metal enclosure.

#### Initial start up:

1. After initial power up or **RESET** button is pressed, the transmitter is reset. The reset button is located inside the battery door.
2. During system reset, all segments of the LCD will be turned on. After one second, the LCD will be initialized and operational. Typical reset displays are shown. Note that the temperature scale is degree F.
3. When reset the transmitter is operating in the manual mode. The time and room temperature are shown.

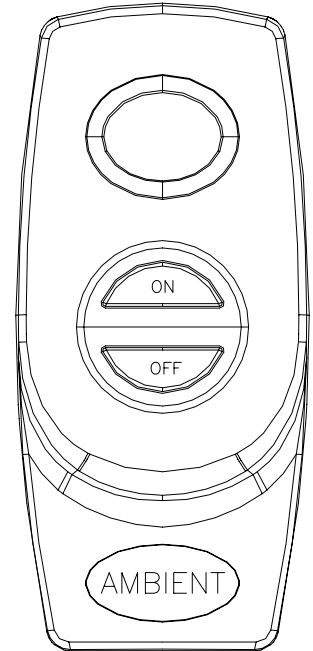
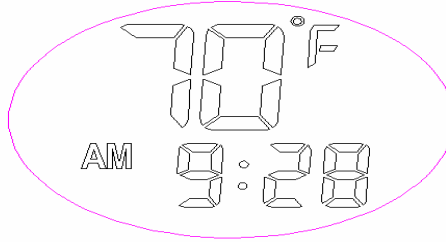

#### Setting Clock:

1. In clock setting mode, only clock and degree is displayed. Press **ON** to select item (hour, minute or degree). Selected item is flashing. Press **OFF** to change. After setting the time, press **ON** to enter manual mode.

#### Manual Mode:

1. Press the **On** button once to turn on the appliance. Press the **OFF** button to turn it off.

#### Low-battery detection:

1. Battery voltage is checked once a minute. When the battery voltage drops to a certain level, the low-battery warning will come on, and the transmitter **will turn off the appliance**. The transmitter will not function anymore until fresh batteries are installed.
2. When the batteries are low, the LCD shows a low battery indicator. The low battery warning will be displayed in any mode.
3. The transmitter will not operate with low batteries. Change the battery before the battery is too weak for normal operation. **TURN THE UNIT OFF BEFORE REPLACING BATTERIES.**

#### Child-proof protection:

1. Press and hold **ON** and **OFF** buttons simultaneously for 3 seconds to enter child-proof mode.
2. The transmitter will not work mode until child-proof mode is deactivated by pressing the **ON** and **OFF** buttons simultaneously for 3 seconds again to exit child-proof mode.

### Transmitter Thermal Shutdown:

1. If transmitter measures a room temperature exceeding 99 degrees Fahrenheit, the LCD will display "HI" and the transmitter will turn off the appliance.
2. Transmitter will not function until the room temperature has dropped below 99 degree Fahrenheit.

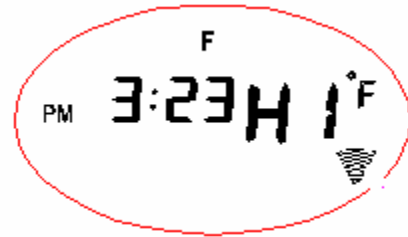

### ***Receiver:***

#### Slide Switch:

1. ON position: the system will remain on until the slide switch is placed in the OFF or RS position.
2. RS position: the system will only operate if the remote receiver receives a signal from the transmitter.
3. OFF position, the system is off. The slide switch should be placed in the OFF position if you will be away for an extended period of time. If the remote receiver is mounted out of children's reach, the OFF position also functions as a safety device by both turning the system off and rendering the receiver inoperable.

### **TESTING YOUR NEW REMOTE CONTROL SYSTEM**

1. Connect the wiring terminal to the appliance. Refer to the appropriate Homeowner's Manual for proper wiring connections to the appliance.
2. Light your gas appliance following the appliance lighting instructions that came with the appliance. Confirm that the pilot light is on; it must be in operation for the remote control to operate the main gas valve. Appliance control knob must be in the ON position. Appliance ON/OFF switch must be in OFF position.
3. Slide the 3 position button on the remote receiver to the ON position. The main gas flame should ignite
4. Slide the button to OFF. The flame should extinguish (the pilot light will remain on).
5. Slide the button to RS (the center position), then press the **ON** button on the transmitter to turn the system to ON. The main gas flame should ignite.
6. Press the **OFF** button on the transmitter to turn the system to OFF. The flame should extinguish (the pilot light will remain on).

## TROUBLESHOOTING

Symptom	Causes	Action
1. LED light on receiver blinking or battery icon on LCD on transmitter. 2. LCD display is blank 3. LCD display shows “funny” display	1. Low Battery	1. Replace batteries. Change batteries every 6 months. 2. Check battery installation and replace batteries. 3. Press Reset button at the back of the transmitter. The reset button is located at the lower left corner behind the battery cover.
4. Appliance does not come on after pressing <b>ON</b> on transmitter	1. Wiring / Electrical Connections	1. Slide the switch to ON, if appliance comes ON, wiring is not the causes. 2. If appliance does not come on, check wiring connections.
	2. Privacy (DIP) switch setting on transmitter does not match receiver	1. Make sure the transmitter and receiver has the same DIP switch settings.
	3. Transmitter measures temperature exceeding 99 degrees Fahrenheit and shows “HI” on LCD	1. Move transmitter to a cooler place and wait until temperature drops below 99 degree.
	4. Distance between the transmitter and receiver is more than 30 feet	1. Make sure the operating distance is less than 30 feet
5. Receiver cannot receive signal.	1. Receiver is installed in an enclosure	1. Make sure the receiver is not located inside an enclosure.

## WARRANTY

This warranty gives you specific legal rights and you may also have other rights that vary from state to state or province to province. Answers to any questions regarding our limited warranty may be obtained by writing our corporate offices.

Ambient Technologies warrants each new Ambient Technologies remote control against any defects that are due to faulty material or workmanship to the original owner, for a period of five years after the original date of purchase. This warranty and our liability does not apply to batteries, nor does it include damage to merchandise or the remote control resulting from accident, alteration, neglect, misuse, improper installation or any other failure to follow Ambient Technologies installation and operating instructions.

Ambient Technologies agrees to repair or replace at its option any Ambient Technologies remote control under warranty provided it is returned postage prepaid to our warranty facility in a padded carton within the warranty period, with proof of the original date of purchase and a brief description of the malfunction. This limited warranty does not include the cost of removal or re-installation.

Ambient Technologies  
149 Cleveland Drive  
Paris KY 40361

**FOR TECHNICAL SUPPORT  
CALL 800-398-6195**